

Product Summary

BV _{DSS}	R _{DS(ON)} Max	Package	I _D T _A = +25°C (Notes 4 & 6)
-60V	85mΩ @ V _{GS} = -10V	SO-8	-3.9A
	125mΩ @ V _{GS} = -4.5V		-3.2A

Description

This MOSFET has been designed to minimize the on-state resistance and yet maintain superior switching performance, making it ideal for high efficiency power management applications.

Applications

- DC-DC Converters
- Power Management Functions
- Disconnect Switches
- Motor Control

Features

- Low On-Resistance
- Fast Switching Speed
- Low Threshold
- Low Gate Drive
- Low Profile SOIC Package
- **Lead-Free Finish; RoHS Compliant (Notes 1 & 2)**
- **Halogen and Antimony Free. "Green" Device (Note 3)**
- **Qualified to AEC-Q101 Standards for High Reliability**
- **An Automotive-Compliant Part is Available Under Separate Datasheet ([ZXMP6A16DN8Q](#))**

Mechanical Data

- Case: SO-8
- Case Material: Molded Plastic, "Green" Molding Compound. UL Flammability Classification Rating 94V-0
- Moisture Sensitivity: Level 1 per J-STD-020
- Terminals: Finish – Matte Tin Annealed over Copper Leadframe. Solderable per MIL-STD-202, Method 208 (E3)
- Weight: 0.074 grams (Approximate)

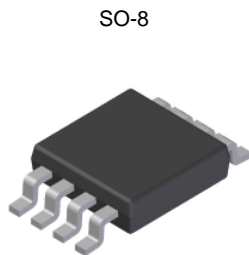

Top View

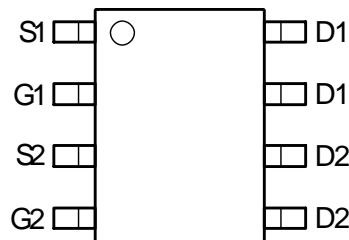

Top View

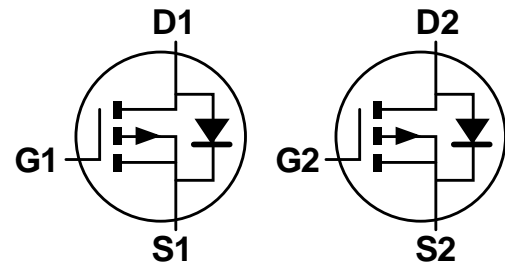

Equivalent Circuit

Ordering Information (Note 4)

Part Number	Case	Packaging
ZXMP6A16DN8TA	SO-8	500/Tape & Reel
ZXMP6A16DN8TC	SO-8	2,500/Tape & Reel

- Notes:
1. EU Directive 2002/95/EC (RoHS) & 2011/65/EU (RoHS 2) compliant. All applicable RoHS exemptions applied.
 2. See http://www.diodes.com/quality/lead_free.html for more information about Diodes Incorporated's definitions of Halogen- and Antimony-free, "Green" and Lead-free.
 3. Halogen- and Antimony-free "Green" products are defined as those which contain <900ppm bromine, <900ppm chlorine (<1500ppm total Br + Cl) and <1000ppm antimony compounds.
 4. For packaging details, go to our website at <http://www.diodes.com/products/packages.html>.

Marking Information

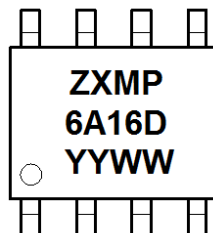

ZXMP6A16D = Product Type Marking Code
 YYWW = Date Code Marking
 YY = Year (ex: 16 = 2016)
 WW = Week (01 - 53)

Maximum Ratings (@T_A = +25°C, unless otherwise specified.)

Characteristic		Symbol	Value	Unit
Drain-Source Voltage		V _{DSS}	-60	V
Gate-Source Voltage		V _{GS}	±20	V
Continuous Drain Current	V _{GS} = 10V	(Notes 7 & 9)	-3.9	A
		T _A = +70°C (Notes 7 & 9)	-3.1	
		(Notes 6 & 9)	-2.9	
		I _D		
Pulsed Drain Current		I _{DM}	-18.3	A
Continuous Source Current (Body Diode)		I _S	-3.2	A
Pulsed Source Current (Body Diode)		I _{SM}	-18.3	A

Thermal Characteristics

Characteristic		Symbol	Value	Unit
Power Dissipation Linear Derating Factor	(Notes 6 & 9)	P _D	1.25	W mW/°C
			10.0	
	(Notes 6 & 10)		1.81	
			14.5	
Thermal Resistance, Junction to Ambient	(Notes 7 & 9)	R _{θJA}	2.15	°C/W
	(Notes 6 & 9)		17	
	(Notes 6 & 10)		100	
Thermal Resistance, Junction to Lead	(Notes 6 & 10)	R _{θJL}	70	°C/W
	(Notes 7 & 9)		60	
Operating and Storage Temperature Range		T _J , T _{STG}	-55 to +150	°C

- Notes:
5. AEC-Q101 V_{GS} maximum is ±16V.
 6. For a device surface mounted on 25mm x 25mm x 1.6mm FR4 PCB with high coverage of single sided 1oz copper, in still air conditions; the device is measured when operating in a steady-state condition.
 7. Same as Note (5), except the device is measured at t ≤ 10 sec.
 8. Same as Note (5), except the device is pulsed with D = 0.02 and pulse width 300µs.
 9. For a dual device with one active die.
 10. For a device with two active die running at equal power.
 11. Thermal resistance from junction to solder-point.

Thermal Characteristics (Continued)

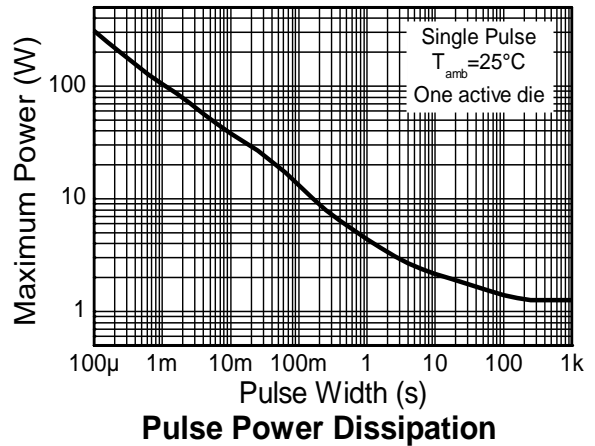
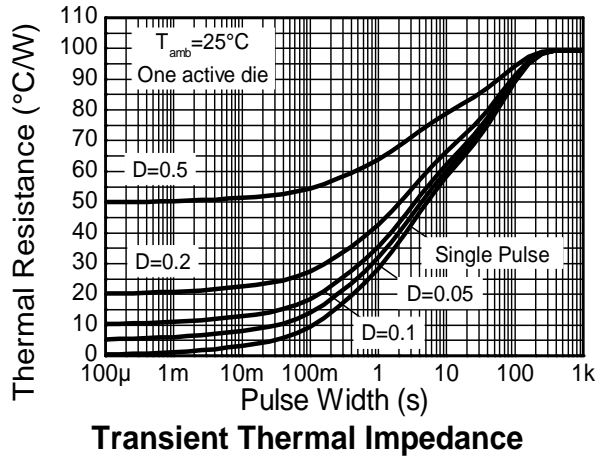
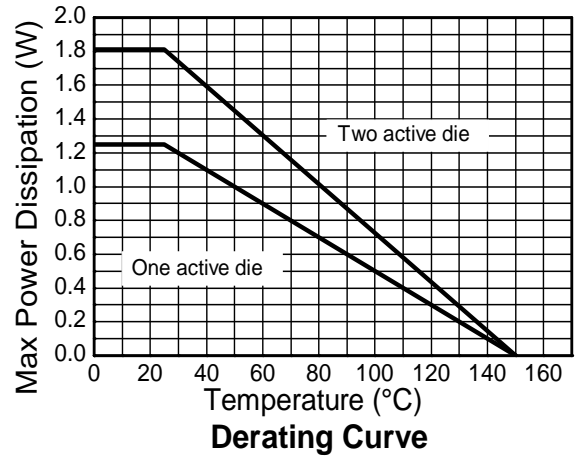
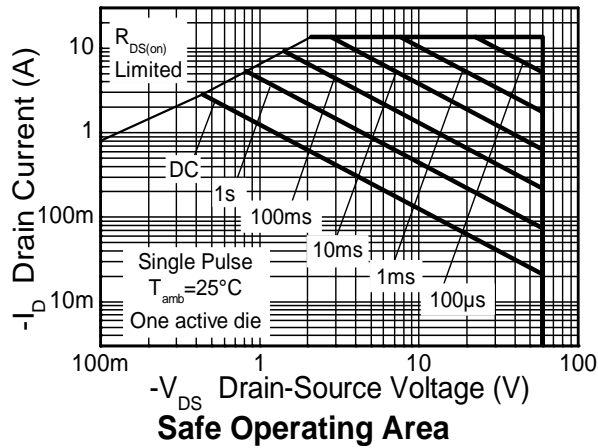

Electrical Characteristics (@T_A = +25°C, unless otherwise specified.)

Characteristic	Symbol	Min	Typ	Max	Unit	Test Condition	
OFF CHARACTERISTICS							
Drain-Source Breakdown Voltage	BV _{DSS}	-60	—	—	V	I _D = -250μA, V _{GS} = 0V	
Zero Gate Voltage Drain Current	I _{DSS}	—	—	-1.0	μA	V _{DS} = -60V, V _{GS} = 0V	
Gate-Source Leakage	I _{GSS}	—	—	±100	nA	V _{GS} = ±20V, V _{DS} = 0V	
ON CHARACTERISTICS							
Gate Threshold Voltage	V _{GS(TH)}	-1.0	—	—	V	I _D = -250μA, V _{DS} = V _{GS}	
Static Drain-Source On-Resistance (Note 12)	R _{DS(ON)}	—	—	85	mΩ	V _{GS} = -10V, I _D = -2.9A	
			—	125		V _{GS} = -4.5V, I _D = -2.4A	
Forward Transconductance (Notes 12 & 13)	g _{FS}	—	7.2	—	S	V _{DS} = -15V, I _D = -2.9A	
Diode Forward Voltage (Note 12)	V _{SD}	—	-0.85	-0.95	V	I _S = -3.4A, V _{GS} = 0V, T _J = +25°C	
Reverse Recovery Time (Note 13)	t _{RR}	—	29.2	—	ns	I _S = -2A, di/dt = 100A/μs,	
Reverse Recovery Charge (Note 13)	Q _{RR}	—	39.6	—	nC	T _J = +25°C	
DYNAMIC CHARACTERISTICS (Note 14)							
Input Capacitance	C _{ISS}	—	1,021	—	pF	V _{DS} = -30V, V _{GS} = 0V, f = 1MHz	
Output Capacitance	C _{OSS}	—	83.1	—	pF		
Reverse Transfer Capacitance	C _{RSS}	—	56.4	—	pF		
Total Gate Charge	Q _G	—	12.1	—	nC	V _{GS} = -5V	V _{DS} = -30V, I _D = -2.9A
Total Gate Charge	Q _G	—	24.2	—	nC	V _{GS} = -10V	
Gate-Source Charge	Q _{GS}	—	2.5	—	nC		
Gate-Drain Charge	Q _{GD}	—	3.7	—	nC		
Turn-On Delay Time	t _{D(ON)}	—	3.5	—	ns	V _{DD} = -30V, V _{GS} = -10V, I _D = -1A, R _G ≅ 6.0Ω	
Turn-On Rise Time	t _R	—	4.1	—	ns		
Turn-Off Delay Time	t _{D(OFF)}	—	35	—	ns		
Turn-Off Fall Time	t _F	—	10	—	ns		

- Notes:
12. Measured under pulsed conditions. Pulse width ≤ 300μs; duty cycle ≤ 2%
 13. For design aid only, not subject to production testing.
 14. Switching characteristics are independent of operating junction temperatures.

Typical Characteristics

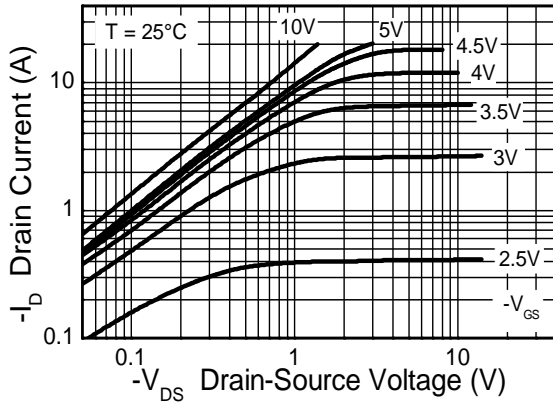

Output Characteristics

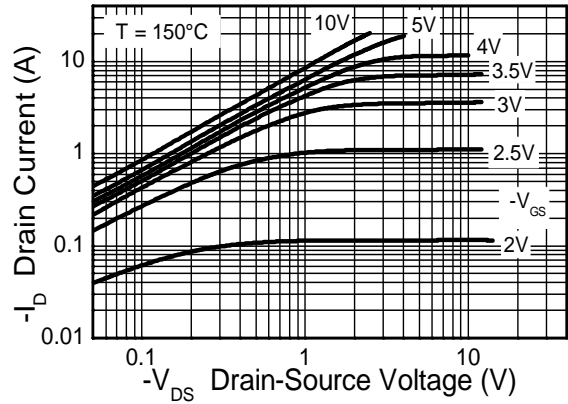

Output Characteristics

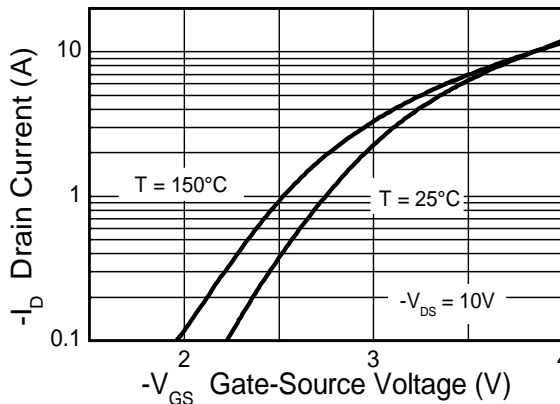

Typical Transfer Characteristics

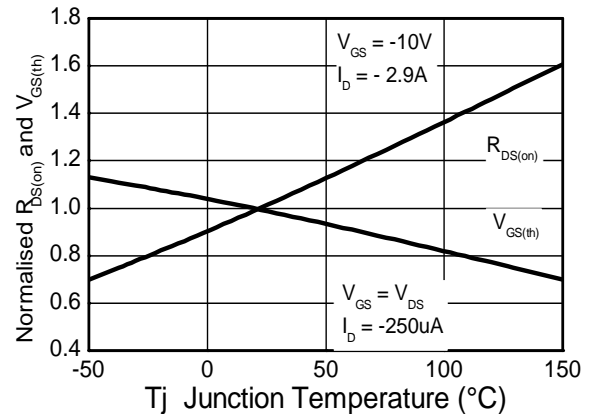

Normalised Curves v Temperature

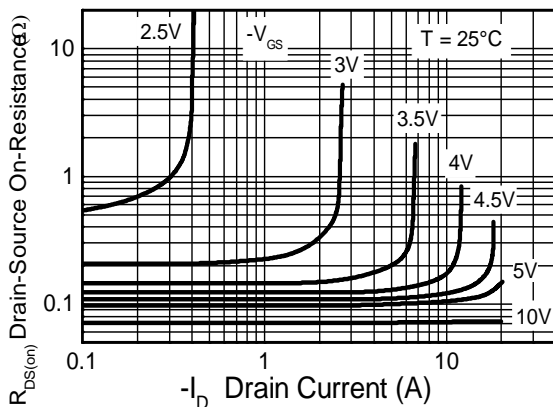

On-Resistance v Drain Current

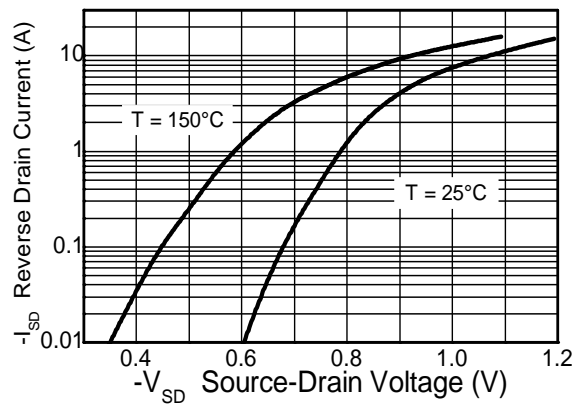

Source-Drain Diode Forward Voltage

Typical Characteristics (Continued)

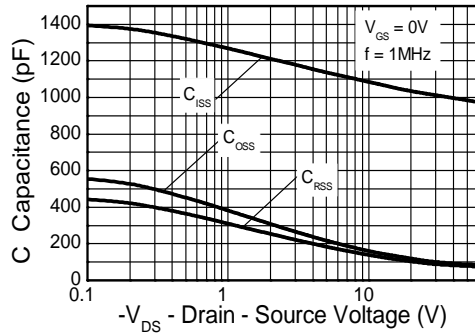

Capacitance v Drain-Source Voltage

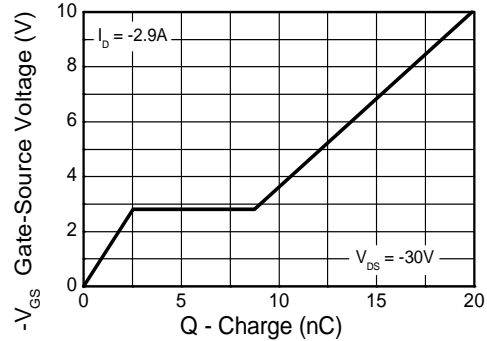

Gate-Source Voltage v Gate Charge

Test Circuits

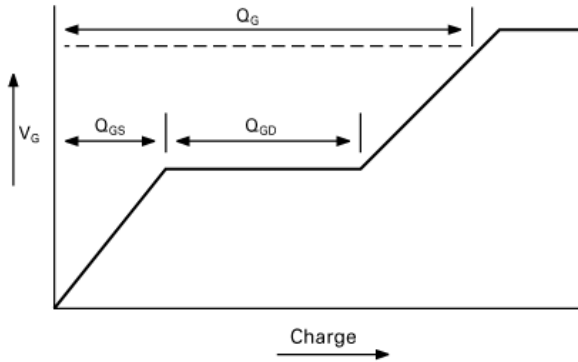

Basic gate charge waveform

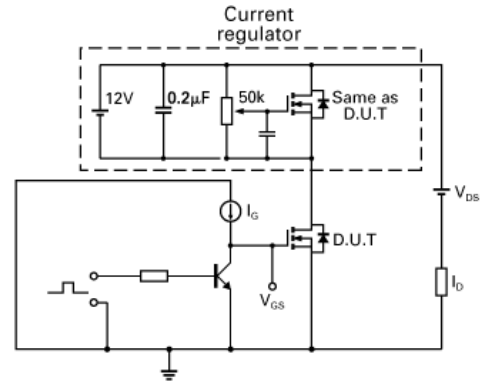

Gate charge test circuit

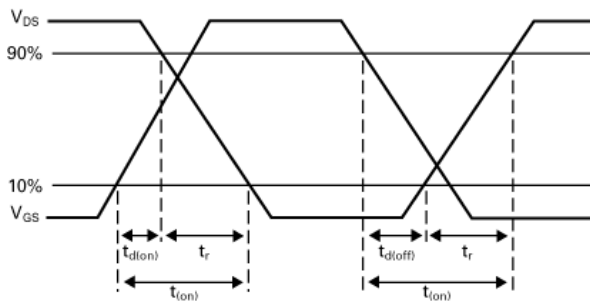

Switching time waveforms

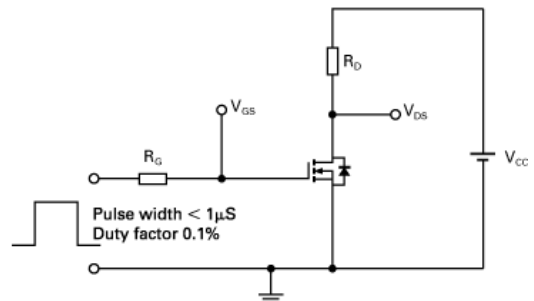

Switching time test circuit

Package Outline Dimensions

Please see <http://www.diodes.com/package-outlines.html> for the latest version.

SO-8

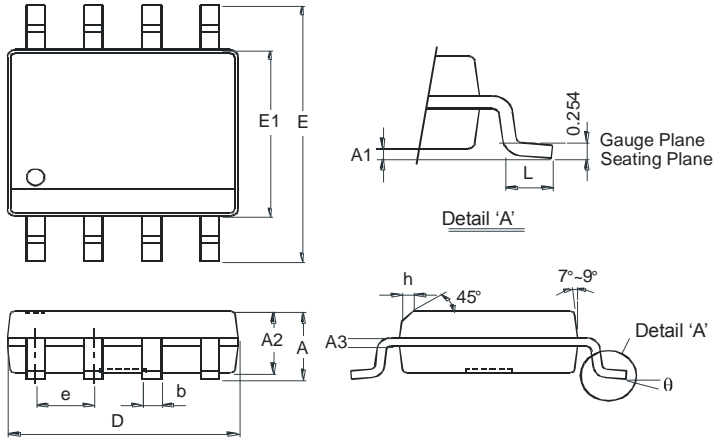

SO-8		
Dim	Min	Max
A	-	1.75
A1	0.10	0.20
A2	1.30	1.50
A3	0.15	0.25
b	0.3	0.5
D	4.85	4.95
E	5.90	6.10
E1	3.85	3.95
e	1.27 Typ	
h	-	0.35
L	0.62	0.82
θ	0°	8°
All Dimensions in mm		

Suggested Pad Layout

Please see <http://www.diodes.com/package-outlines.html> for the latest version.

SO-8

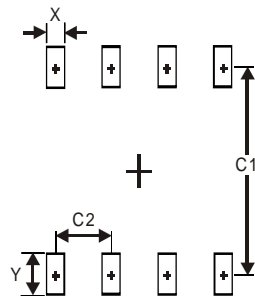

Dimensions	Value (in mm)
X	0.60
Y	1.55
C1	5.4
C2	1.27

IMPORTANT NOTICE

DIODES INCORPORATED MAKES NO WARRANTY OF ANY KIND, EXPRESS OR IMPLIED, WITH REGARDS TO THIS DOCUMENT, INCLUDING, BUT NOT LIMITED TO, THE IMPLIED WARRANTIES OF MERCHANTABILITY AND FITNESS FOR A PARTICULAR PURPOSE (AND THEIR EQUIVALENTS UNDER THE LAWS OF ANY JURISDICTION).

Diodes Incorporated and its subsidiaries reserve the right to make modifications, enhancements, improvements, corrections or other changes without further notice to this document and any product described herein. Diodes Incorporated does not assume any liability arising out of the application or use of this document or any product described herein; neither does Diodes Incorporated convey any license under its patent or trademark rights, nor the rights of others. Any Customer or user of this document or products described herein in such applications shall assume all risks of such use and will agree to hold Diodes Incorporated and all the companies whose products are represented on Diodes Incorporated website, harmless against all damages.

Diodes Incorporated does not warrant or accept any liability whatsoever in respect of any products purchased through unauthorized sales channel. Should Customers purchase or use Diodes Incorporated products for any unintended or unauthorized application, Customers shall indemnify and hold Diodes Incorporated and its representatives harmless against all claims, damages, expenses, and attorney fees arising out of, directly or indirectly, any claim of personal injury or death associated with such unintended or unauthorized application.

Products described herein may be covered by one or more United States, international or foreign patents pending. Product names and markings noted herein may also be covered by one or more United States, international or foreign trademarks.

This document is written in English but may be translated into multiple languages for reference. Only the English version of this document is the final and determinative format released by Diodes Incorporated.

LIFE SUPPORT

Diodes Incorporated products are specifically not authorized for use as critical components in life support devices or systems without the express written approval of the Chief Executive Officer of Diodes Incorporated. As used herein:

A. Life support devices or systems are devices or systems which:

1. are intended to implant into the body, or
2. support or sustain life and whose failure to perform when properly used in accordance with instructions for use provided in the labeling can be reasonably expected to result in significant injury to the user.

B. A critical component is any component in a life support device or system whose failure to perform can be reasonably expected to cause the failure of the life support device or to affect its safety or effectiveness.

Customers represent that they have all necessary expertise in the safety and regulatory ramifications of their life support devices or systems, and acknowledge and agree that they are solely responsible for all legal, regulatory and safety-related requirements concerning their products and any use of Diodes Incorporated products in such safety-critical, life support devices or systems, notwithstanding any devices- or systems-related information or support that may be provided by Diodes Incorporated. Further, Customers must fully indemnify Diodes Incorporated and its representatives against any damages arising out of the use of Diodes Incorporated products in such safety-critical, life support devices or systems.

Copyright © 2016, Diodes Incorporated

www.diodes.com